

TIMKEN**The Timken Company**

4500 Mt Pleasant St. NW

N. Canton, OH 44720

Phone: (234) 262-3000

E-Mail: CustomerCAD@timken.com • Web site: www.timken.com

Part Number 3203 ATN1/2RS, Timken® Double Row Angular Contact Ball Bearings (3200, 3300)

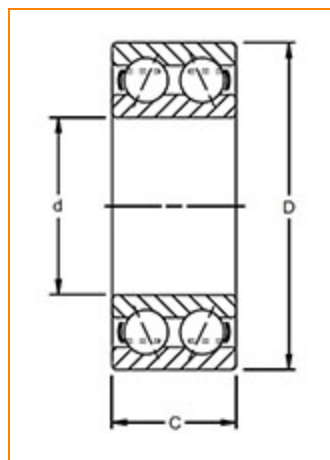

[Dimensions](#) | [Specifications](#) | [Basic Load Ratings](#) | [Abutment and Fillet Dimensions](#)

Dimensions

d - Bore	17.00 mm 0.6693 in
D - Outer Diameter	40.00 mm 1.5748 in
C - Ring Width	17.5 mm 0.6890 in
Contact Angle	30 °

Specifications

Features	Contact Seals
Ball Type	STEEL



Cage Type	Molded
Cage Material	Nylon
Bearing Weight	0.1 Kg 0.214 lb
Design Units	METRIC

Basic Load Ratings

C0 - Static Radial Rating	8410 N 1890 lbf
C1 ISO - Dynamic Radial Rating	12750 N 2866 lbf

Abutment and Fillet Dimensions

R - Inner Ring "To Clear" Radius ¹	0.60 mm 0.024 in
r - Outer Ring "To Clear" Radius ²	0.60 mm 0.024 in
da - Inner Ring Backing Diameter	21.4 mm 0.843 in
Da - Outer Ring Backing Diameter	35.6 mm 1.402 in

¹ Maximum housing fillet radius that bearing corners will clear.

² Maximum shaft fillet radius that bearing corners will clear.

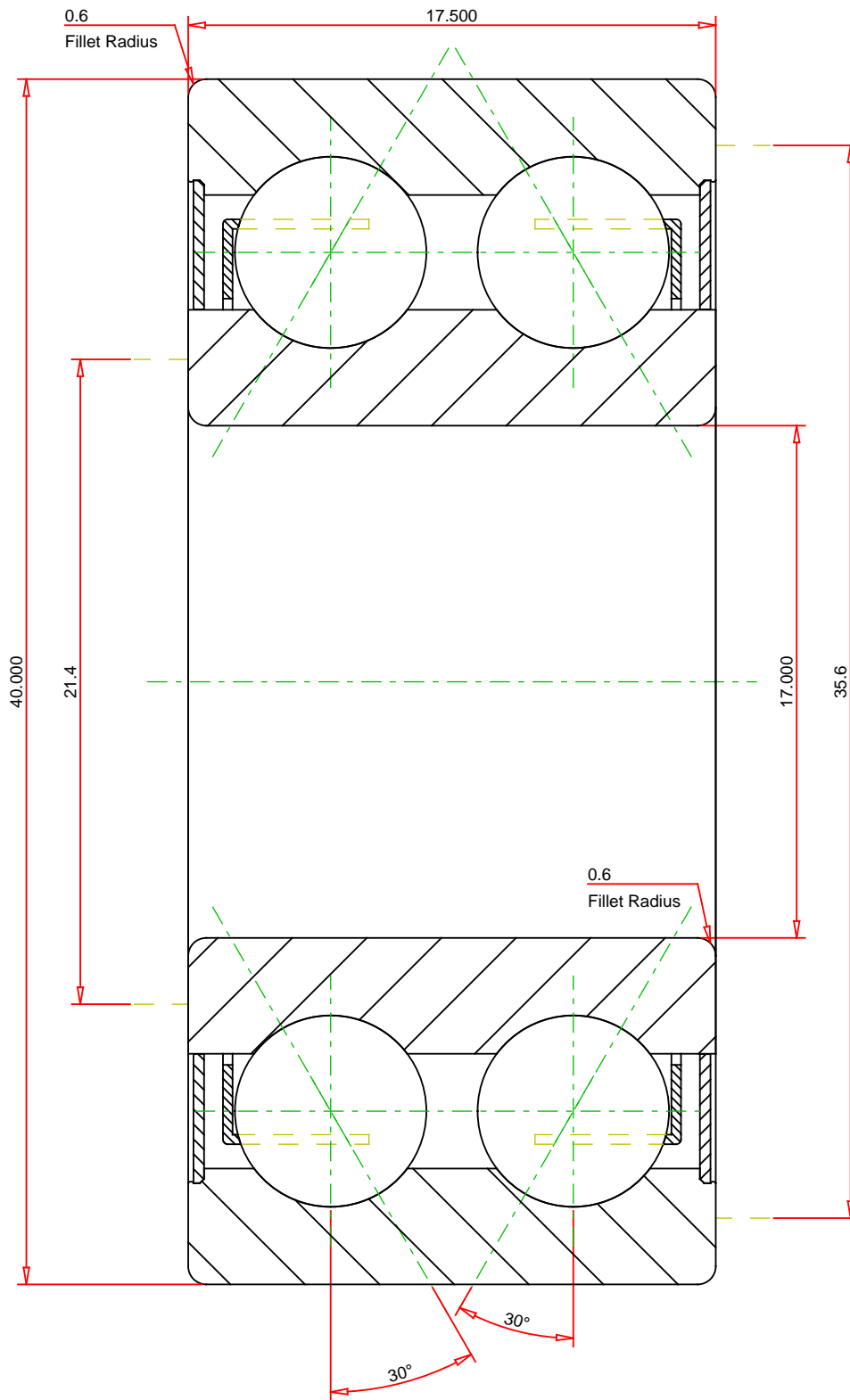

METRIC UNITS

Number of Balls Per Row	8
Bearing Weight	0.100 kg

TIMKEN®

THE TIMKEN COMPANY
NORTH CANTON, OHIO USA

3203 ATN1/2RS	
Timken® Double Row Angular Contact Ball Bearings (3200, 3300)	
Dynamic Load Rating	12750 N
Static Load Rating	8410 N

Every reasonable effort has been made to ensure the accuracy of the information contained in this writing, but no liability is accepted for errors, omissions or for any other reason.

FOR DISCUSSION ONLY